

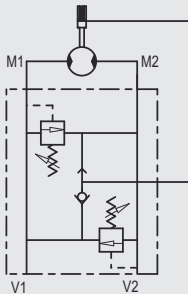

HYDRAULIC DIAGRAM (with brake unclamping)



USE AND OPERATION:

Made up by 2 relief valves with crossed tank, this valve is used to block pressure to a certain setting in the 2 ports of an actuator/hydraulic motor. It's ideal to provide protection against sudden shock pressures and to adjust different pressures in the 2 ports of an hydraulic circuit as well. Direct flange is ideal for Danfoss motors type OMS, OMP-OMR, OMT and compatibles and provides a maximum safety, very low pressure drops and solid installation.

MATERIALS AND FEATURES:

Body : zinc-plated steel
Internal parts : hardened and ground steel.
Seals : BUNA N standard
Poppet type : minor leakage

APPLICATIONS:

Flange M1 and M2 directly to the motor and connect ports V1 and V2 to pressure flow.

ON REQUEST:

- different setting range (see the table)
- other setting available (CODE/T: please specify the desired setting)
- single acting with just 1 relief valve available (CODE/ SE)
- brake unclamping (CODE/ SF)

PRESSURE / FLOW

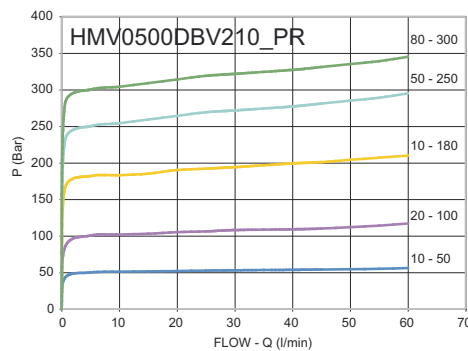
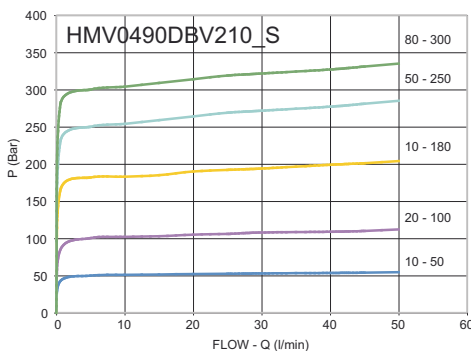

Oil temperature: 50°C - Oil viscosity: 30 cSt

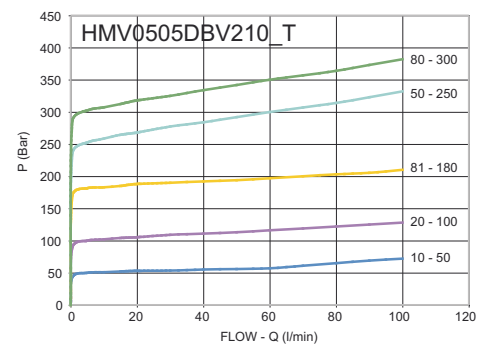

DUAL CROSS RELIEF VALVE HMV...DBV210...

TYPE	MAX FLOW Lt./min
HMV0490DBV210_S ½"	50
HMV0500DBV210_PR ½"	60
HMV0505DBV210_T ¾"	100

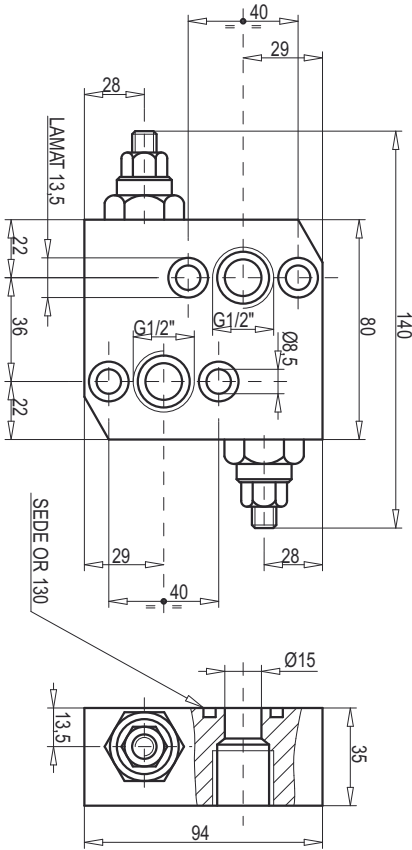

HMV0500DBV210_PR

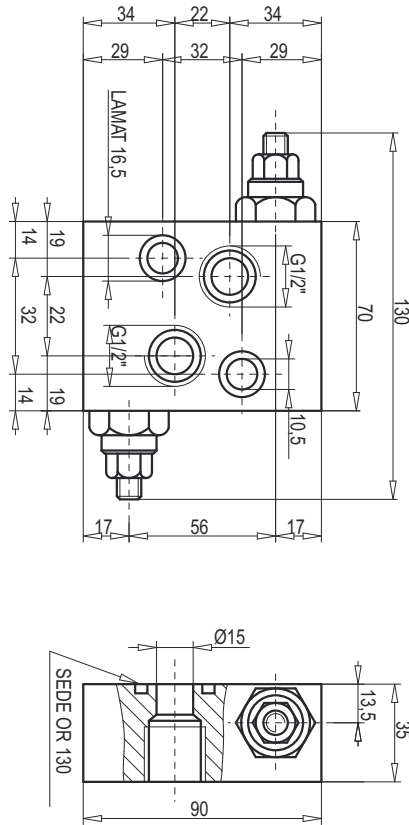

HMV0490DBV210_S

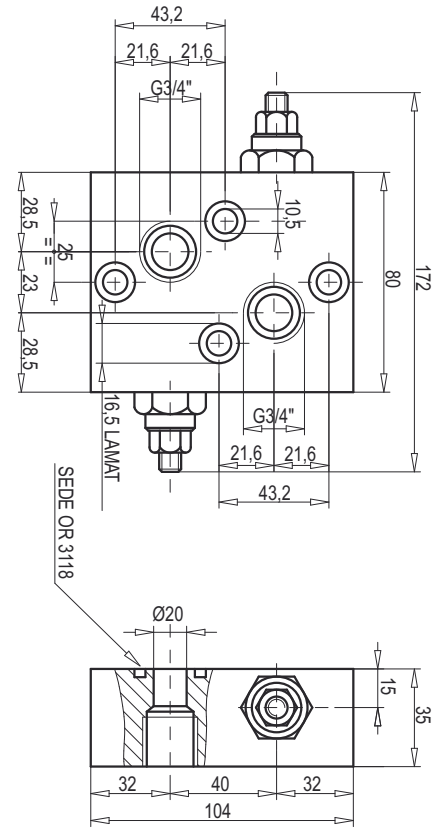

HMV0505DBV210_T

TYPE	V1 - V2	WEIGHT
	GAS	Kg
HMV0490DBV210_S	G ½"	1,326
HMV0500DBV210_PR	G ½"	1,752
HMV0505DBV210_T	G ¾"	1,920

SPRINGS

Setting range (bar)	Pressure increase (bar/turn) Q = 4 l/min	Standard setting (bar)
10 - 50*	7	30
20 - 100	12	75
10 - 180 STANDARD	30	90
50 - 250	45	130
80 - 300	50	150

*For setting less than 70 Bar: Q = 12 l/min

ADJUSTEMENT

CODE/V	Handknob
CODE/PP	Arranged for sealing cap
CODE/P	Sealing cap